





















Inhalt - Contents - Contenu - Inhoud - contenuto -contenido-conteúdo - περιεχόμενα

# Smile Cream 06 320

Schrank 2 Türen 1 Schubkasten

Beschlagbeutel:

<b>A</b>  18 X	<b>B</b>  15 ohne Rand 18 X	<b>C</b>  3 x 16 14 X	<b>D</b>  SW 4 1 X
<b>E</b>  7 x 40 großer Kopf 4 X	<b>F</b>  14 X	<b>G</b>  4 X	<b>H</b>  8 X
<b>I</b>  H7 6 X	<b>J</b>  Invo Krieffung 0 6 X	<b>K</b>  35 x 5 12 X	<b>L</b>  1 X
<b>M</b>  8 x 30 10 X	<b>N</b>  1 X Kippschutz	<b>O</b>  24 X	<b>P</b>  24 X
<b>R</b>  450mm HD links 2 X	<b>S</b>  450mm HD rechts 2 X	<b>T</b>  6,3 x 9 8 X	<b>U</b>  6,3 x 50 1 X

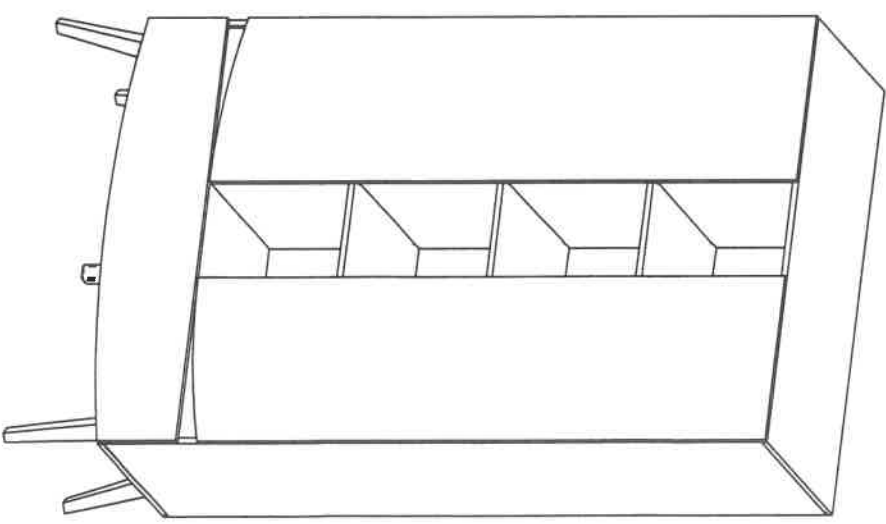
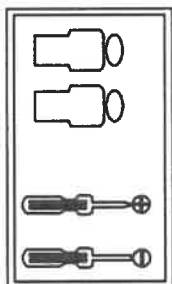

Den Schrank zum Transportieren anheben. Bitte nicht schieben

Lift the cabinet to move it. Please don't push  
Til de kast op voor transport. Duw alsjeblieft niet

**Inhalt - Contents - Contenu - Inhoud - contenido - conteúdo - περιεχόμενο**

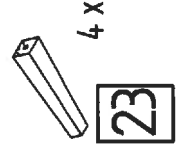
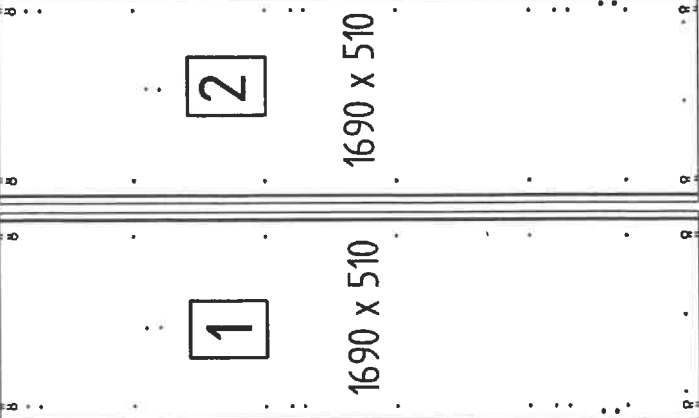
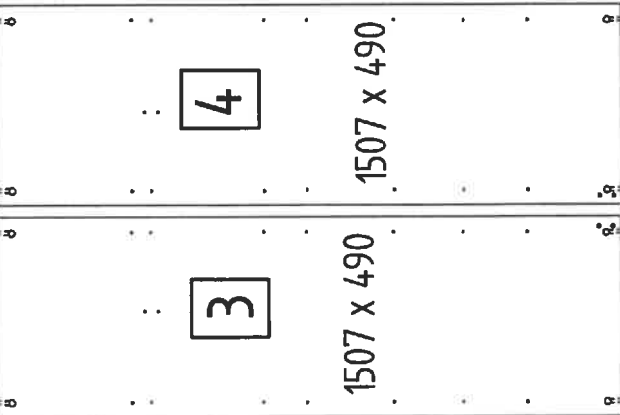
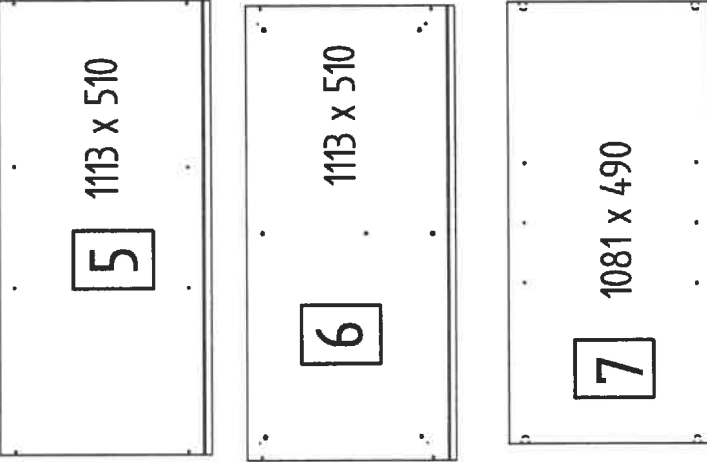
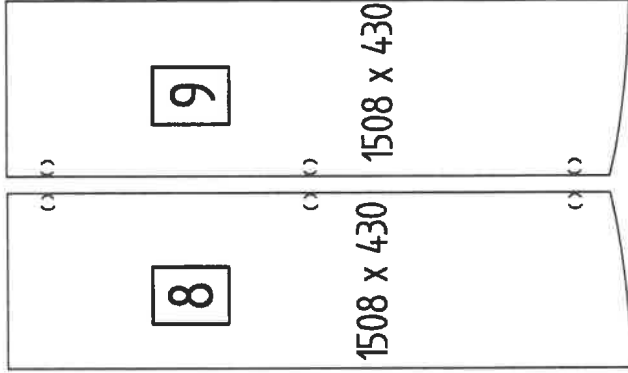
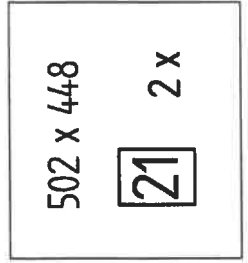
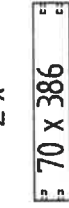
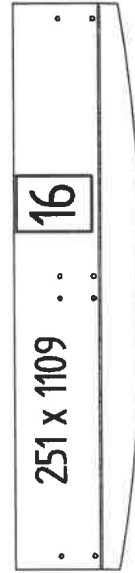
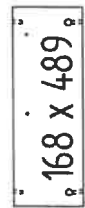
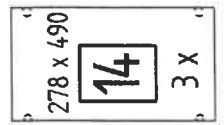
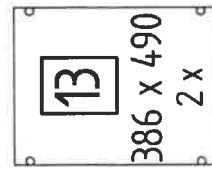
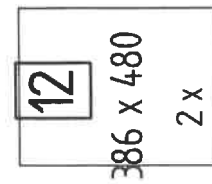
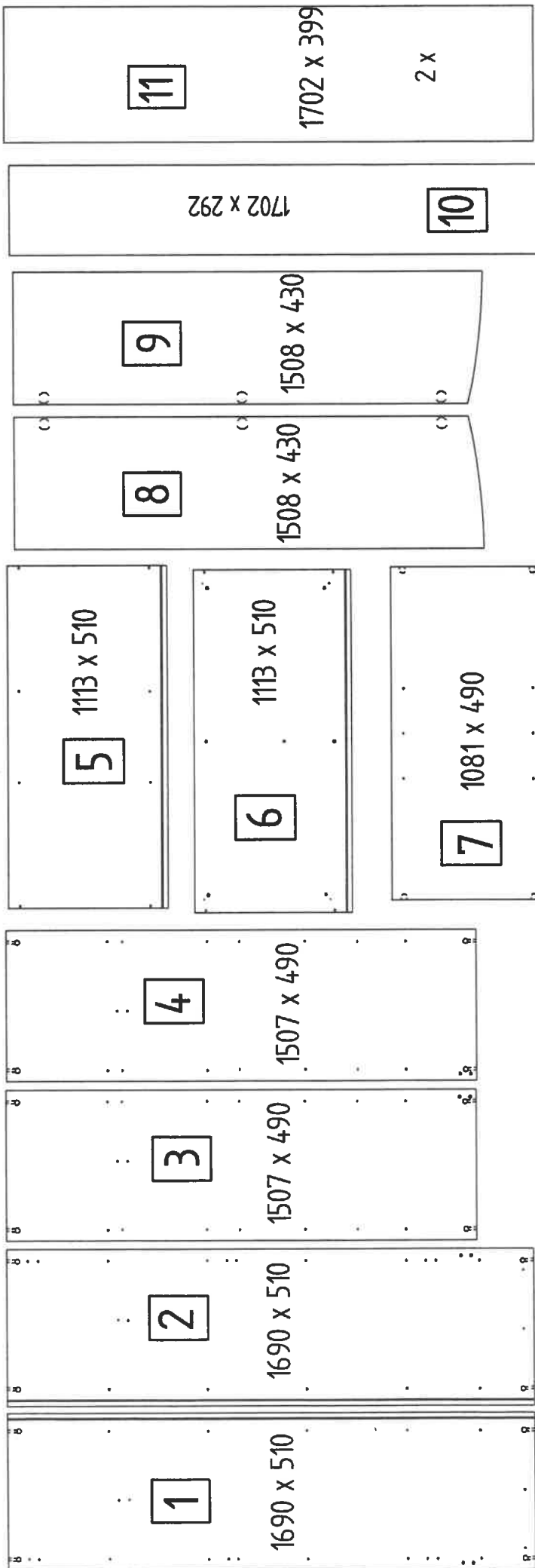

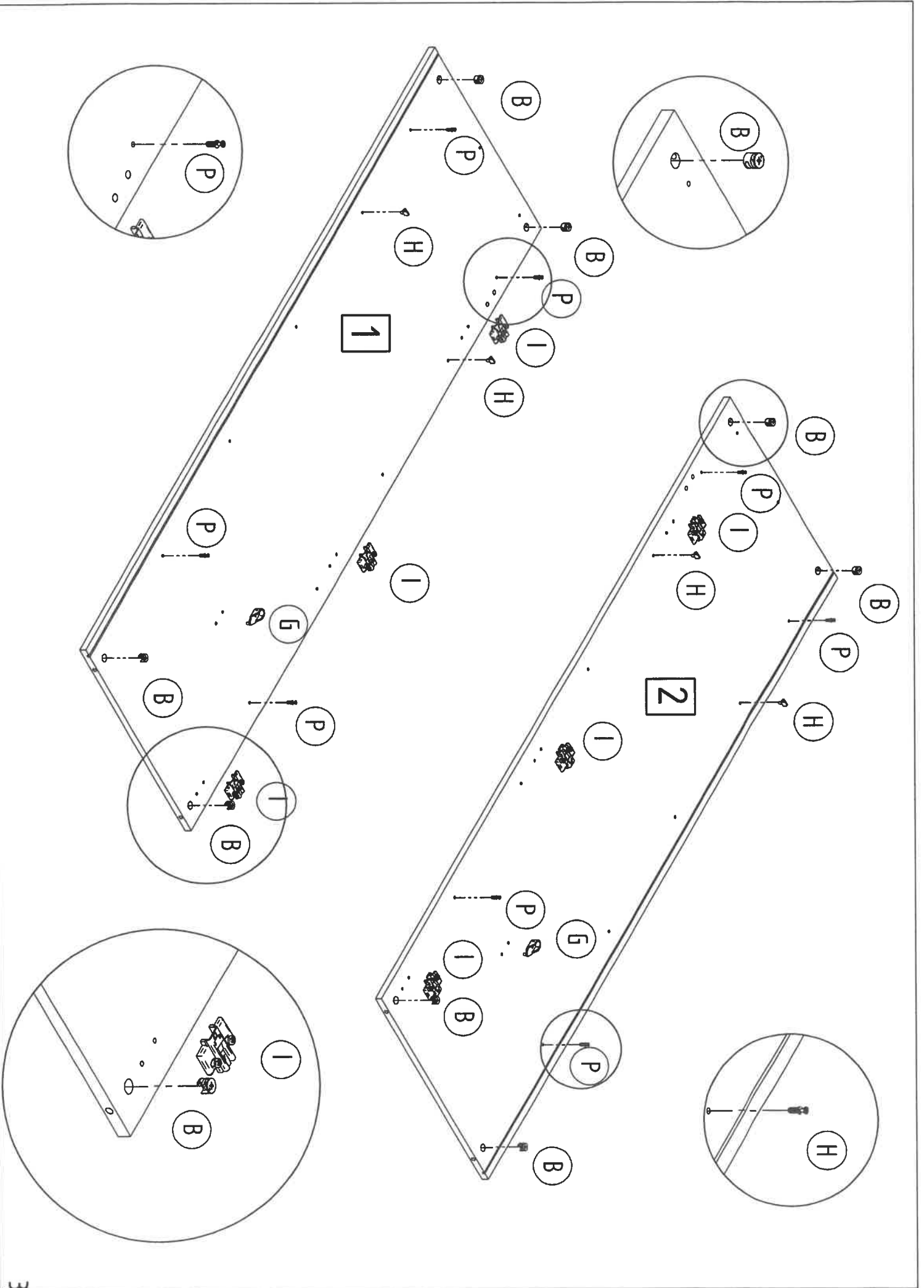

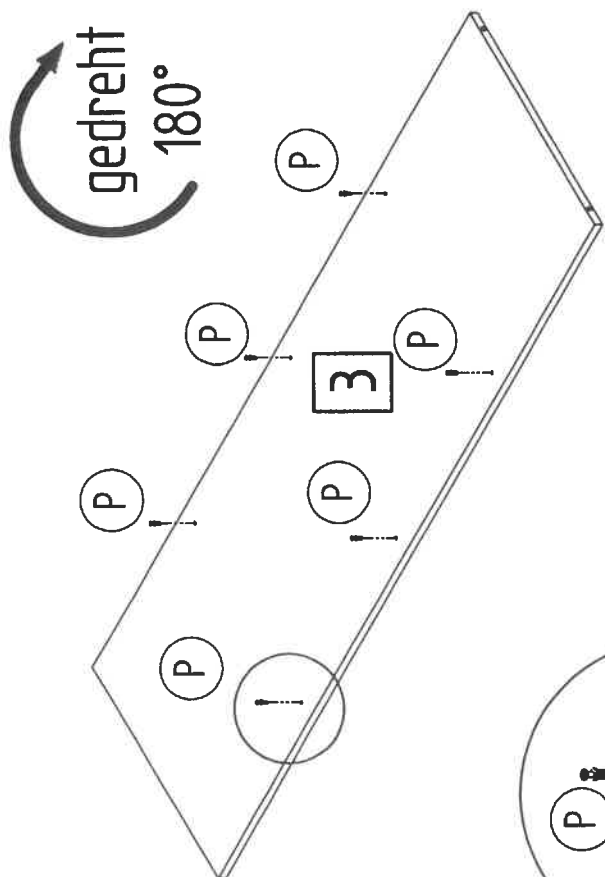

gedreht  
180°

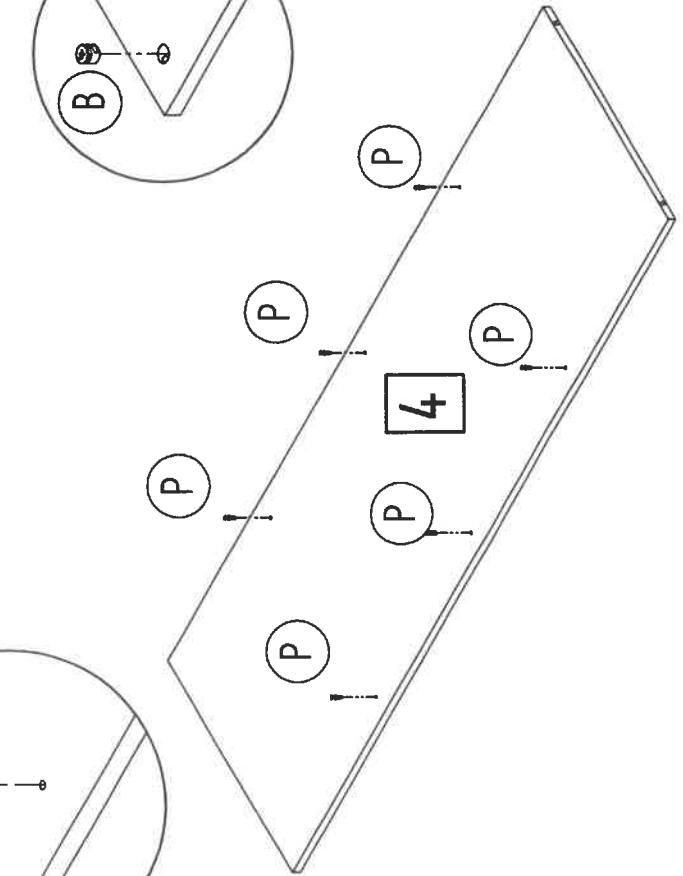
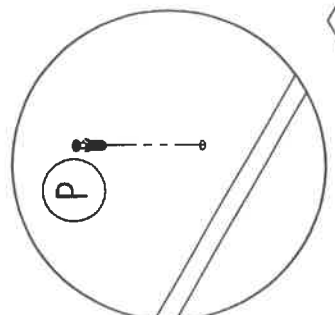
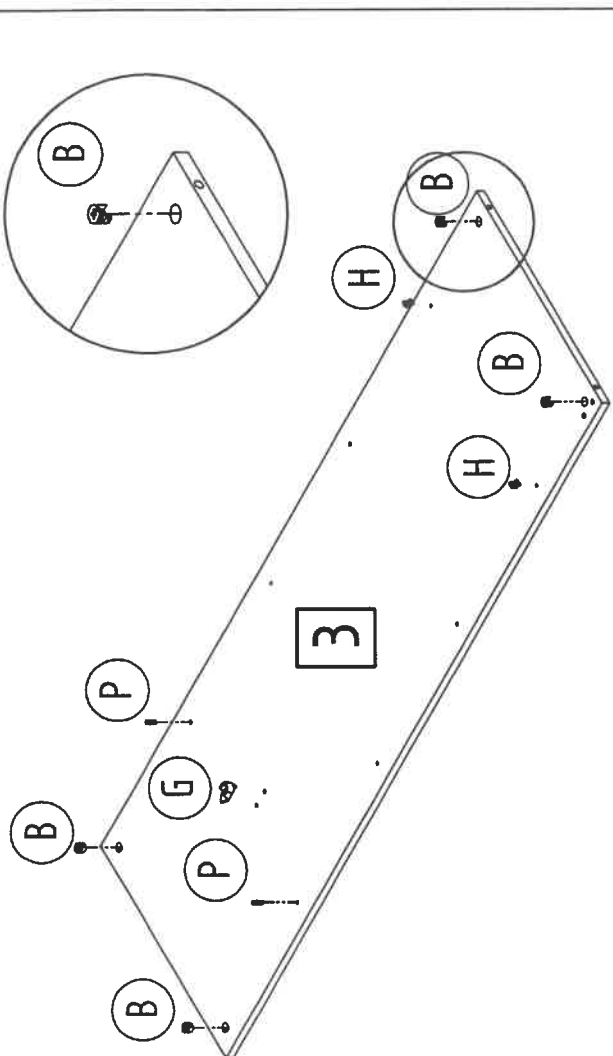

gedreht  
180°

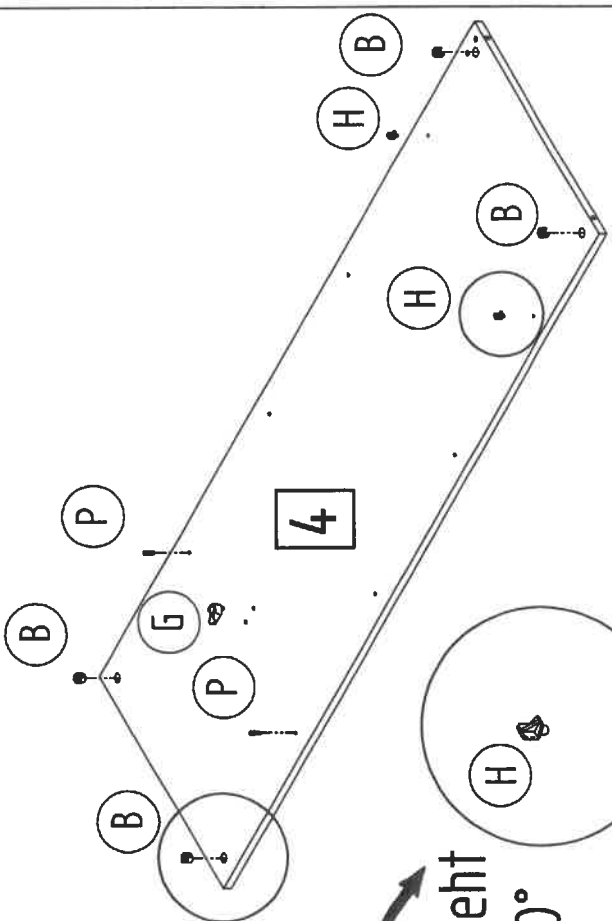



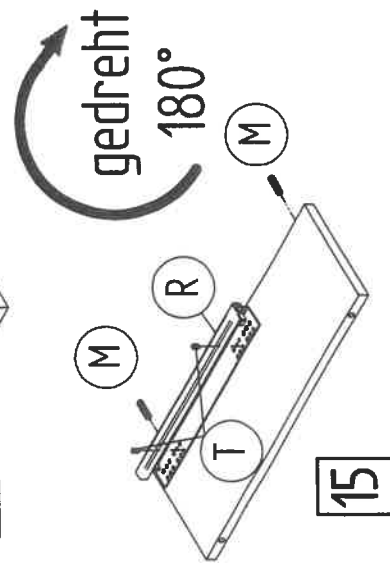
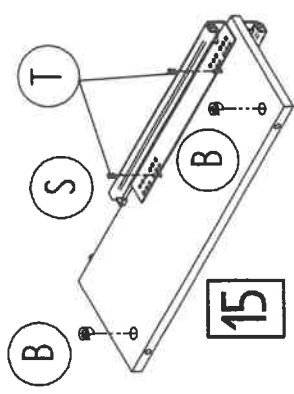
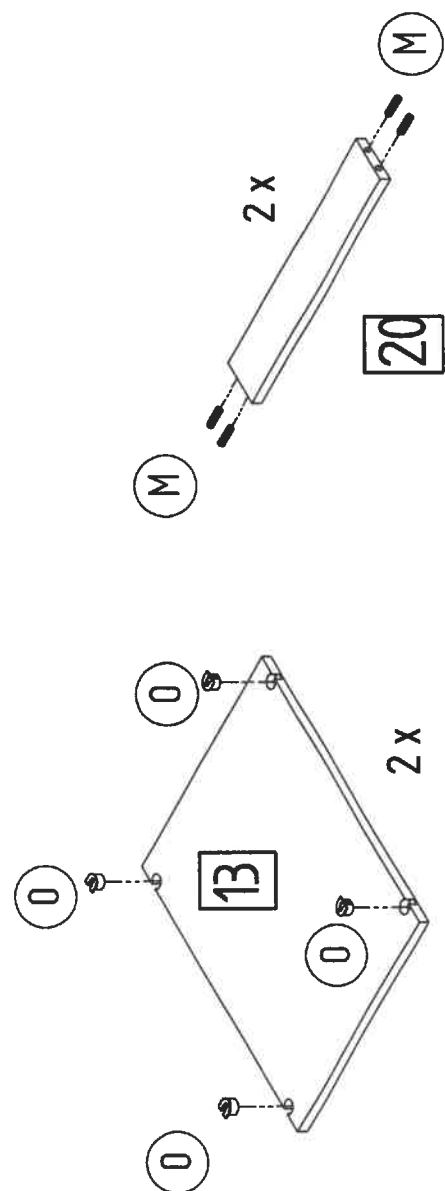
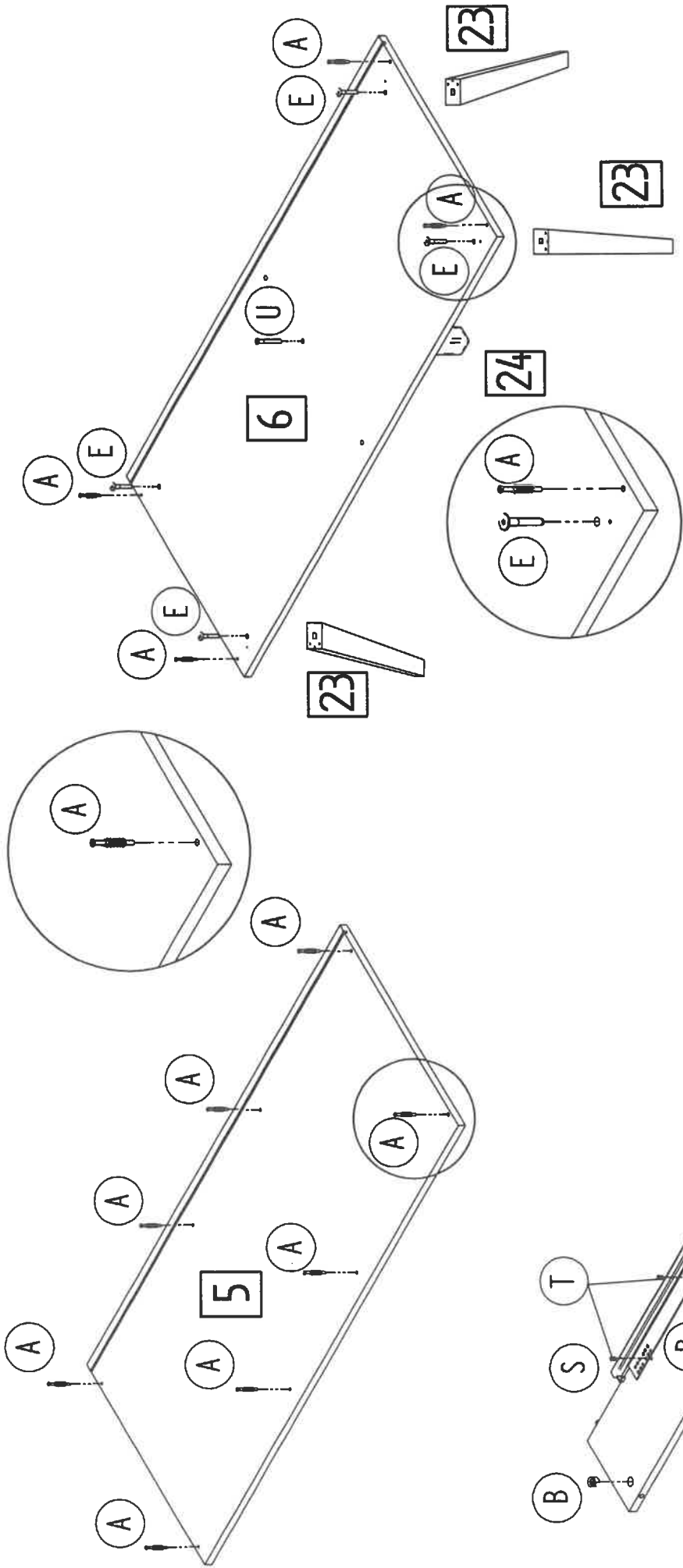

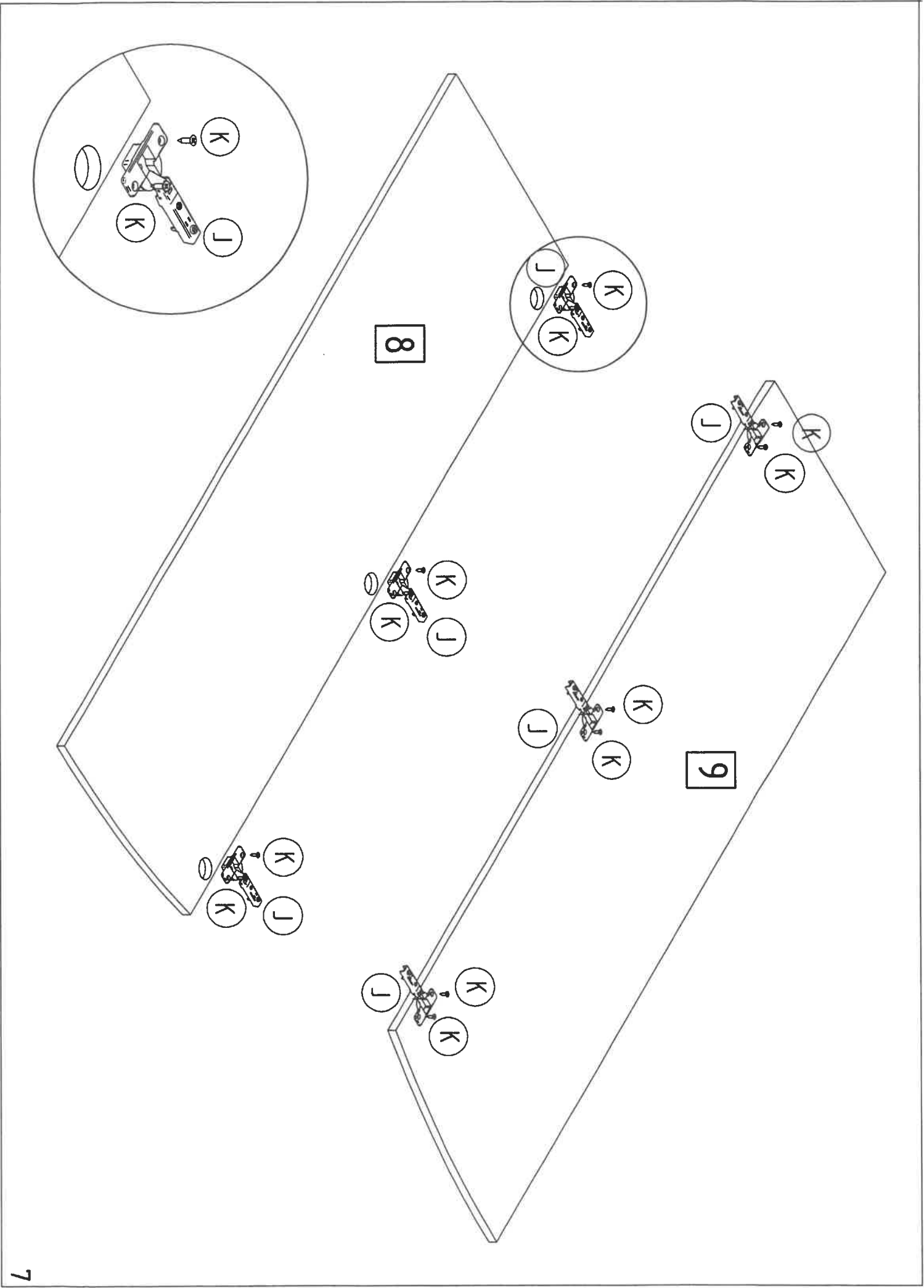



17

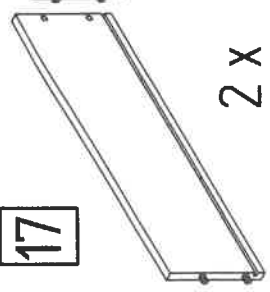

2 X

19

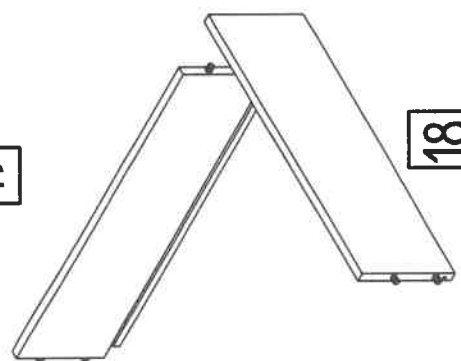

18

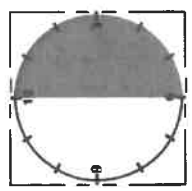

30 min

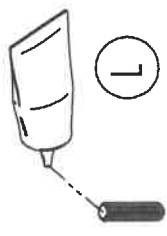

L



Vor weiterer Montage der Beschläge den Leim 30 min abbinden lassen.  
 Before further installation of the fittings the glue thicken for 30 minutes.  
 Avant l'installation ultérieure des raccords, la colle épaissir pendant 30 minutes.  
 Voor verdere montage van het beslag de lijm dik gedurende 30 minuten.  
 Prima ulteriore installazione dei raccordi attendere la colla per 30 minuti.  
 Antes de la instalación posterior de los accesorios de la cola esperar durante 30 minutos.  
 Antes da instalação posterior dos acessórios a engrassar cola durante 30 minutos.  
 Πριν από την περαιτέρω εγκατάσταση των εξαρτημάτων πυκνώσει η κόλλα για 30 λεπτά.

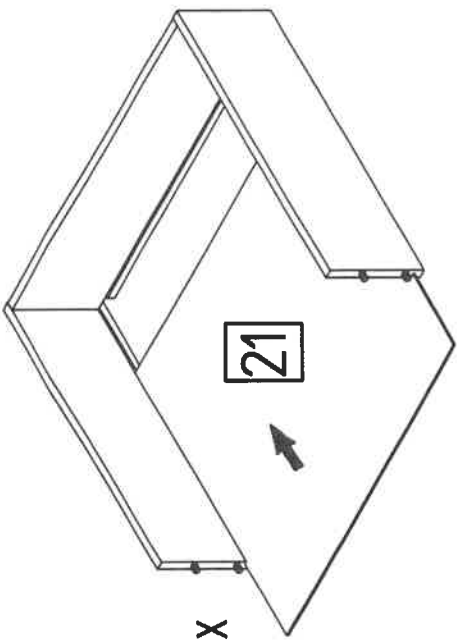

21

2 X

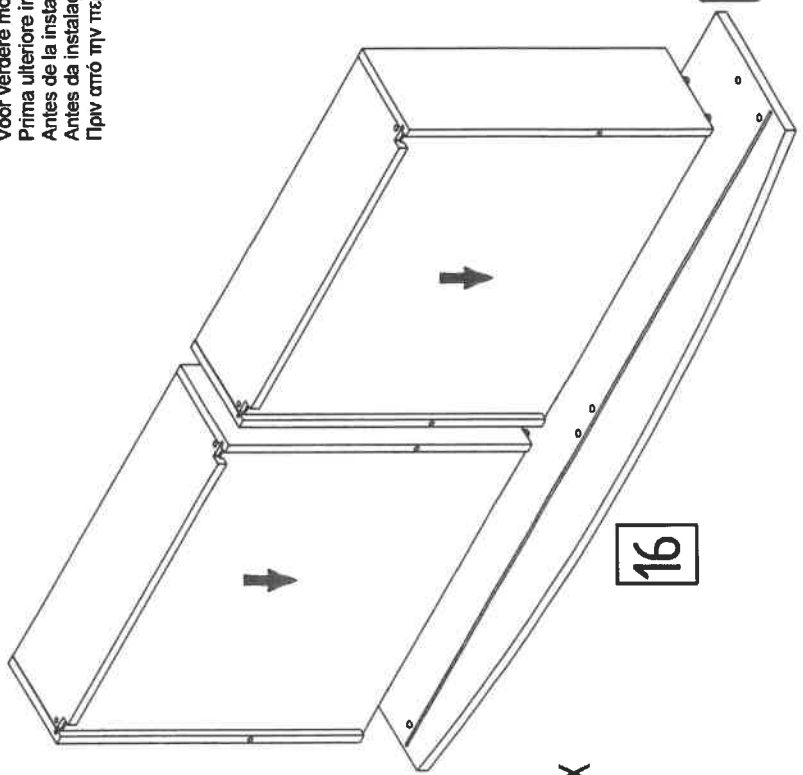

16

3 X

30 min

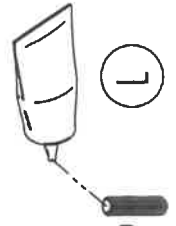

L

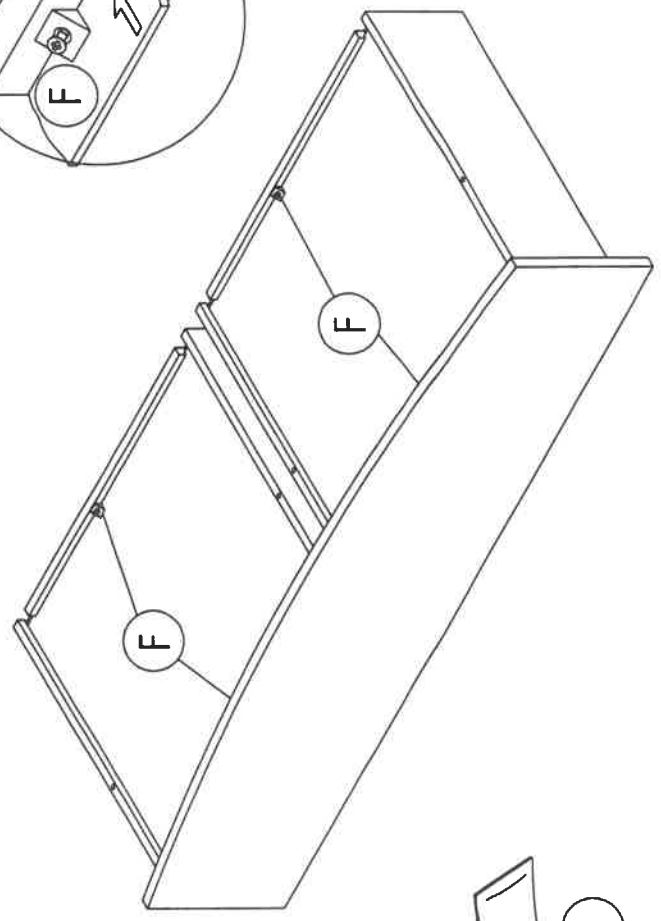
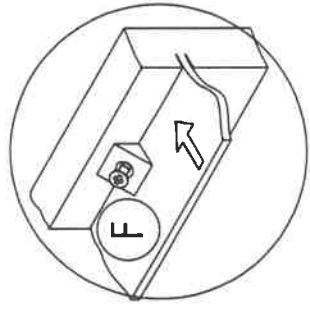

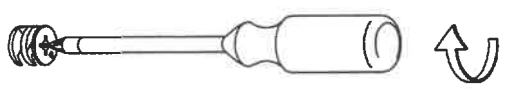
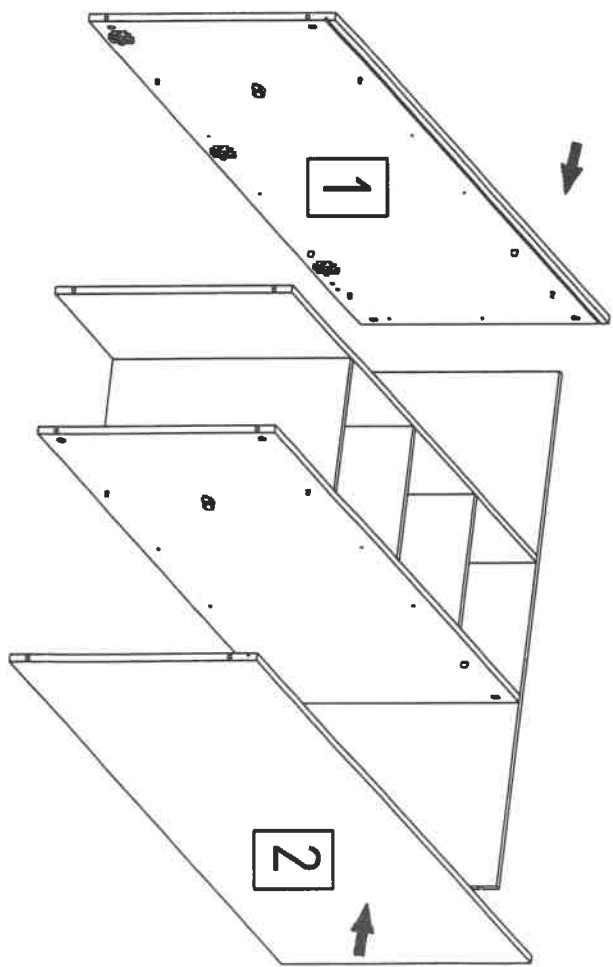
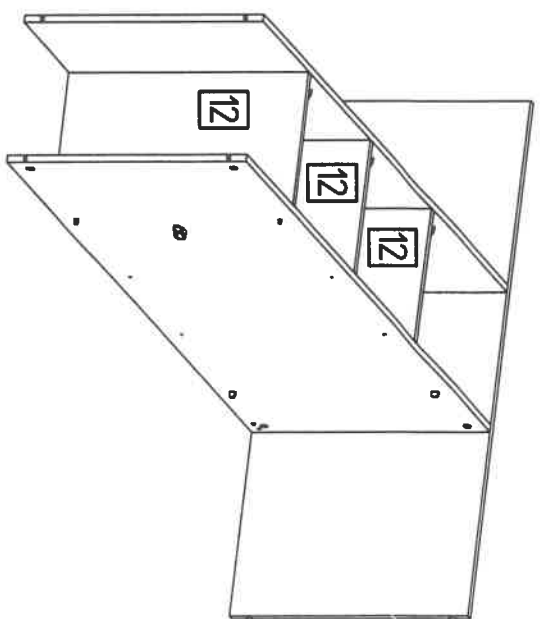
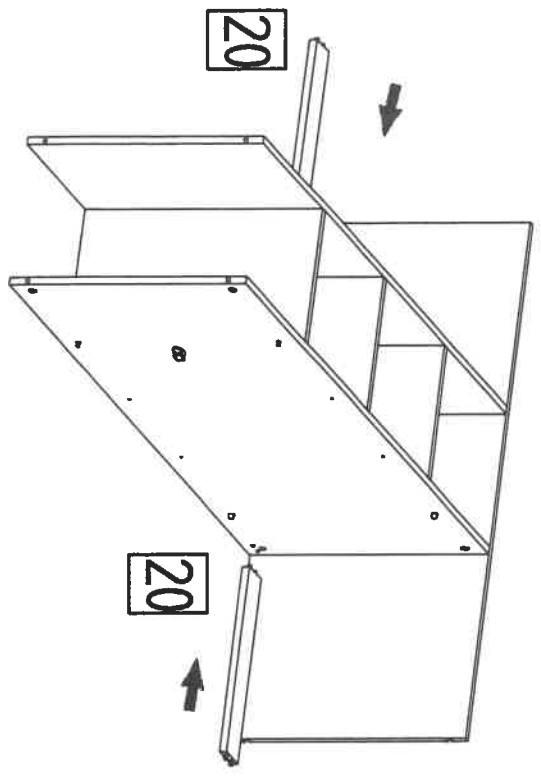
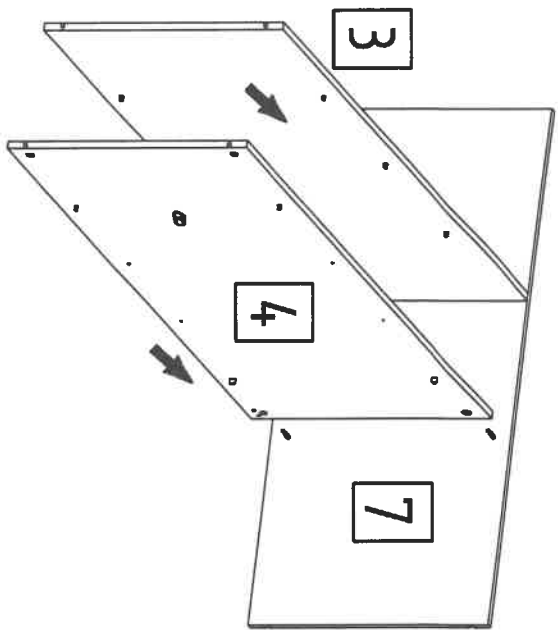

# Zusammenbau:

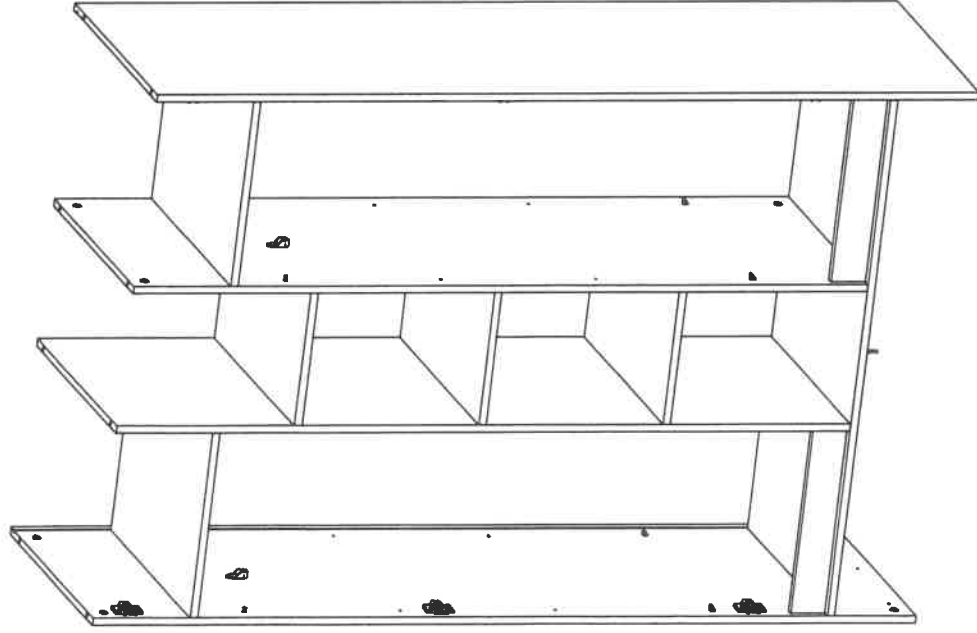
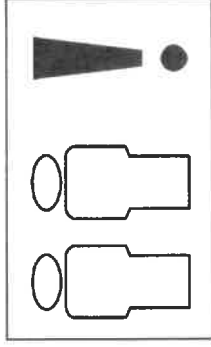

Schrank mit 2 Personen aufrichten

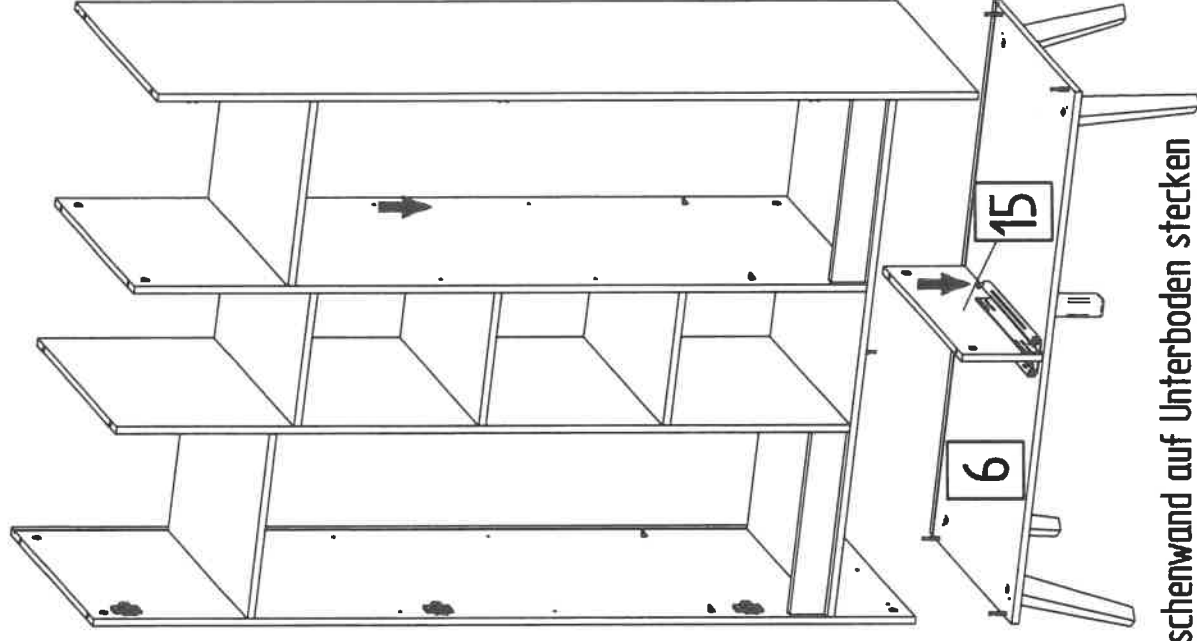
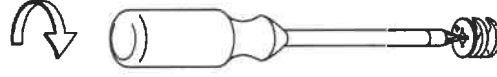

Zwischenwand auf Unterboden stecken  
anschliessend vormontierten Korpus mit 2  
Personen auf den Unterboden setzen

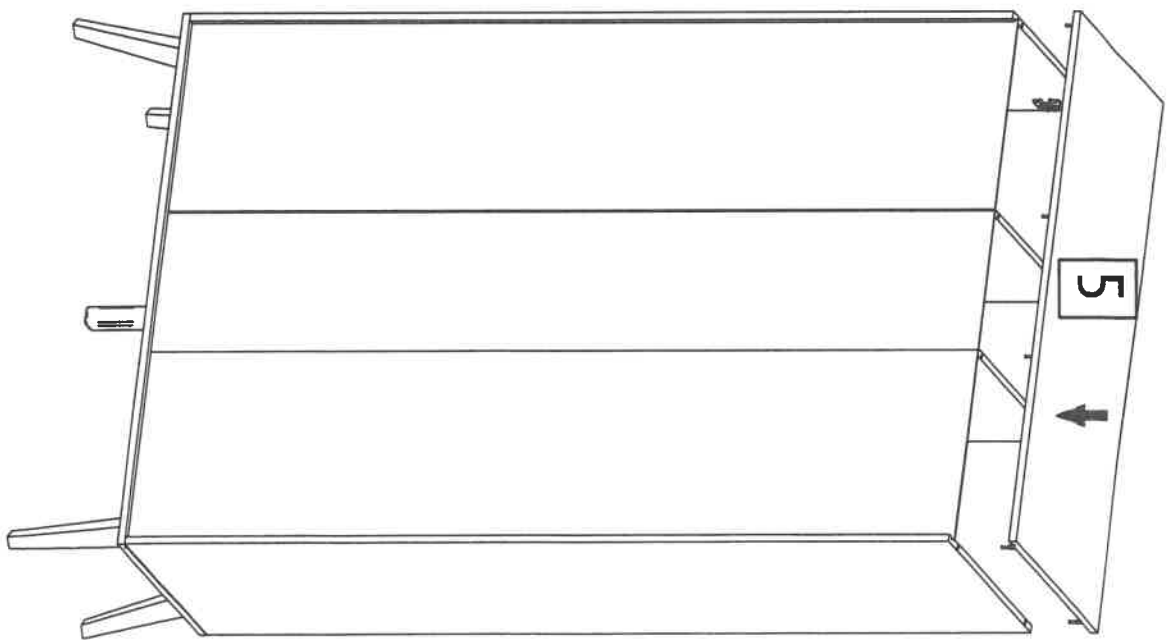
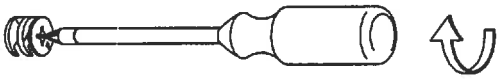
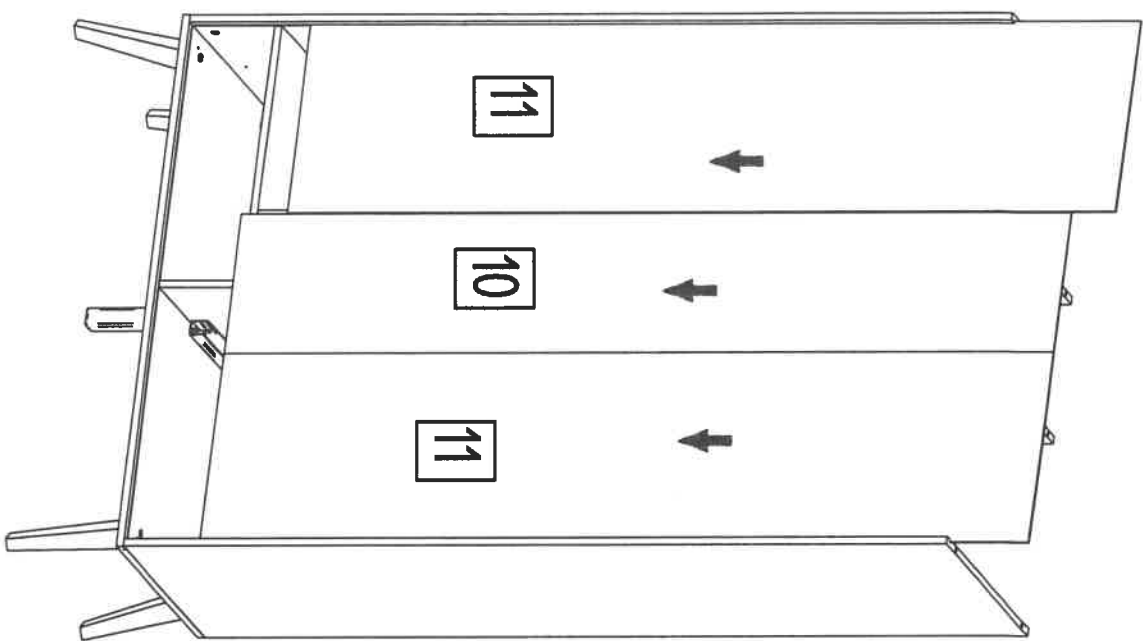

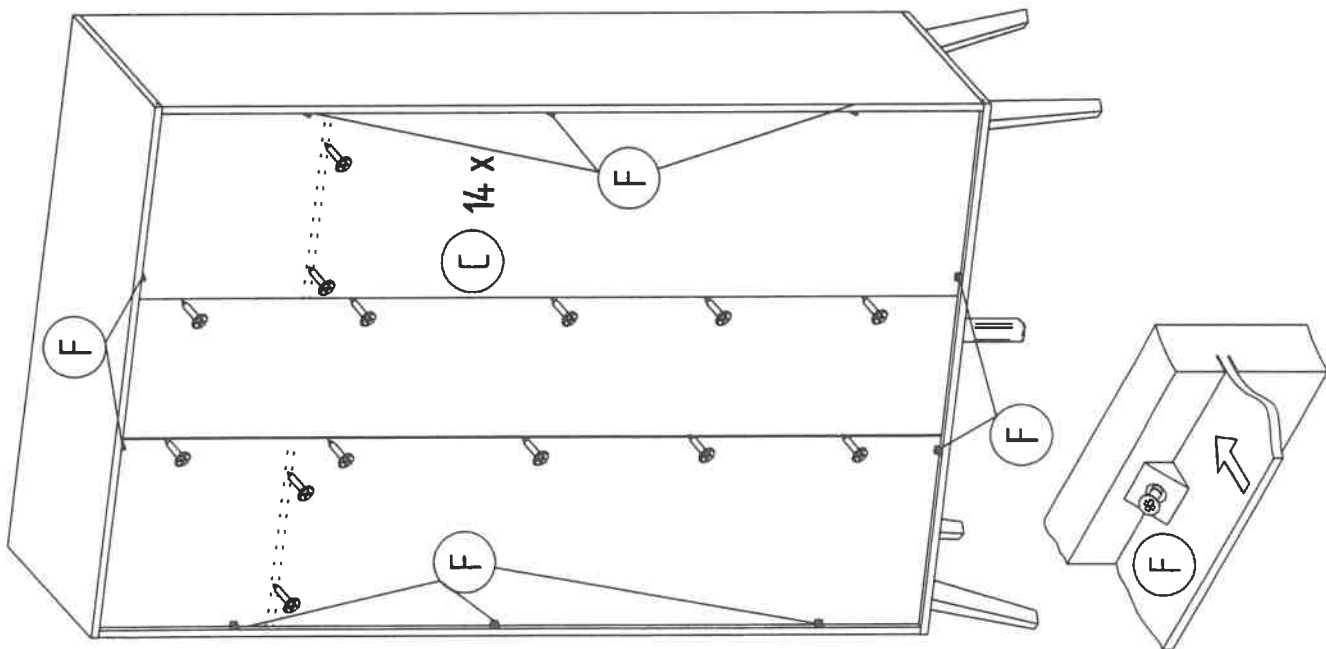
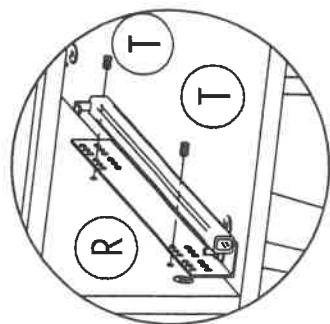
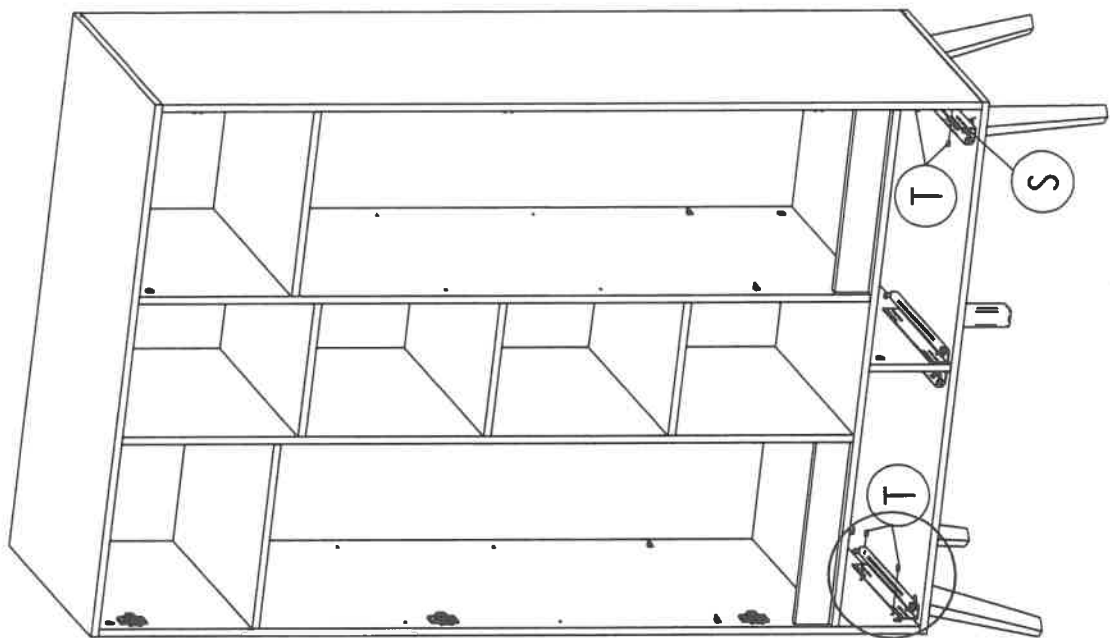

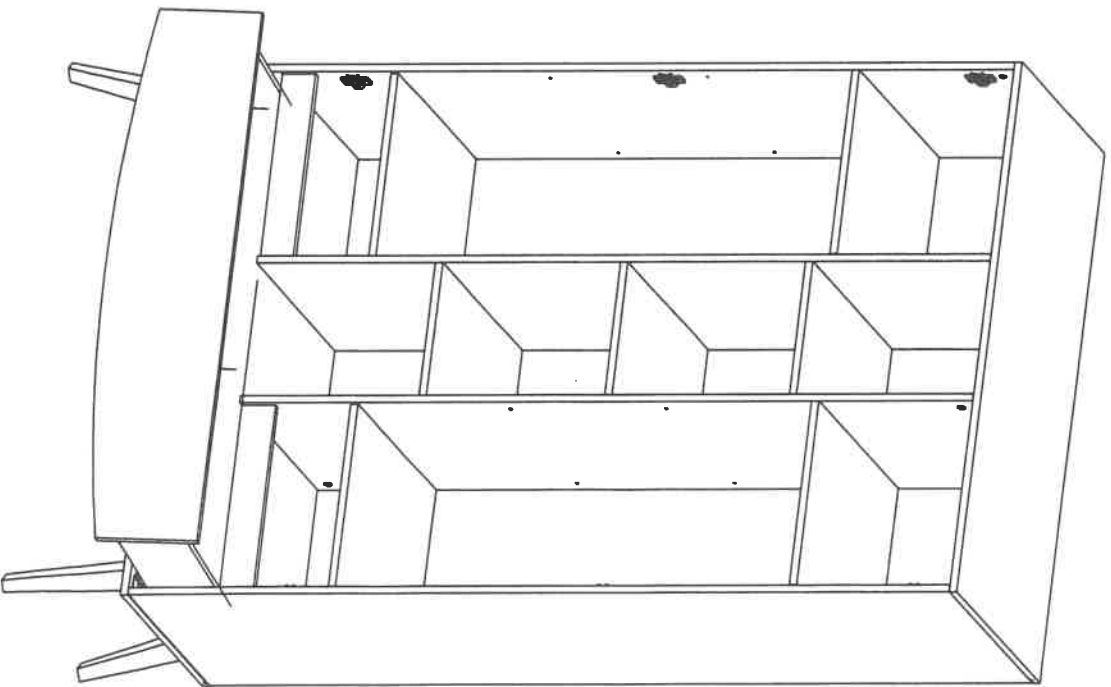
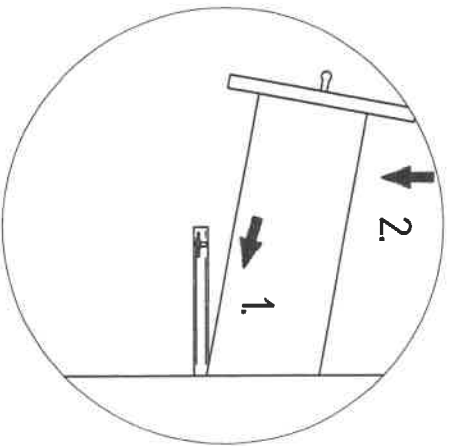
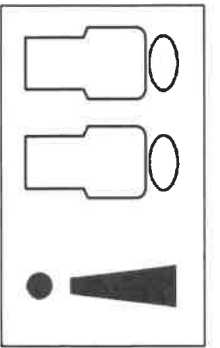
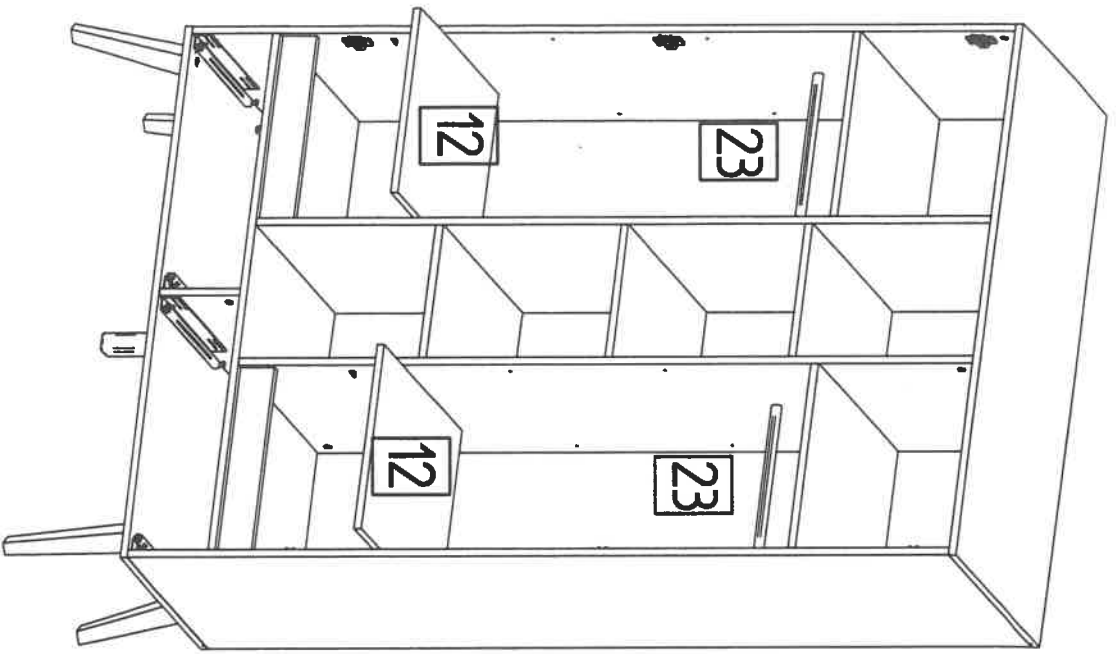

... weitere Infos über unsere Produkte unter  
[www.schardt.com](http://www.schardt.com)

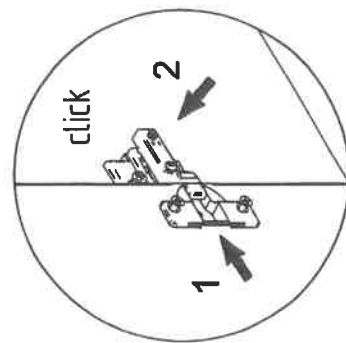
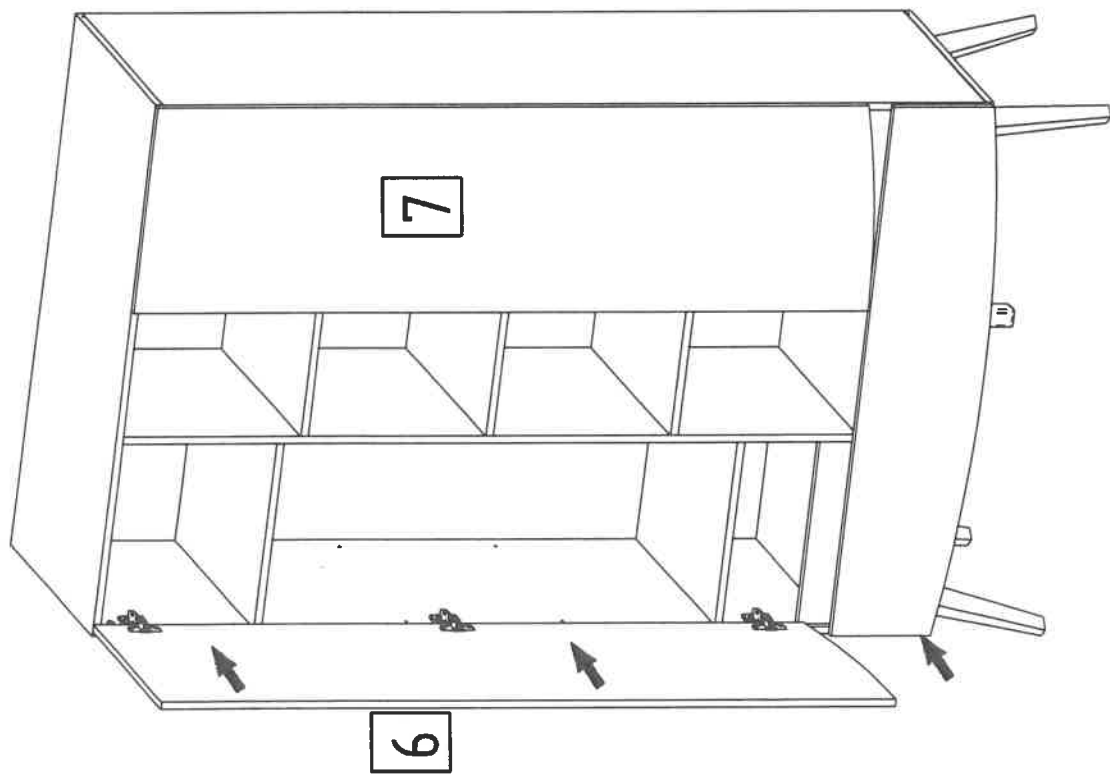

Den Schrank zum Transportieren anheben. Bitte nicht schieben  
Lift the cabinet to move it. Please don't push  
Til de kast op voor transport. Duw alsjebliëft niet

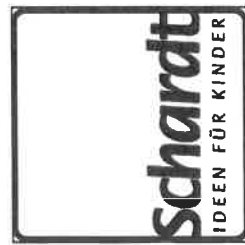

Schardt GmbH & Co. KG  
Am Riegel 15  
96268 Mitwitz  
Tel. 09266/9907-0  
Fax 09266/9907-77  
E-Mail: [info@schardt.com](mailto:info@schardt.com)

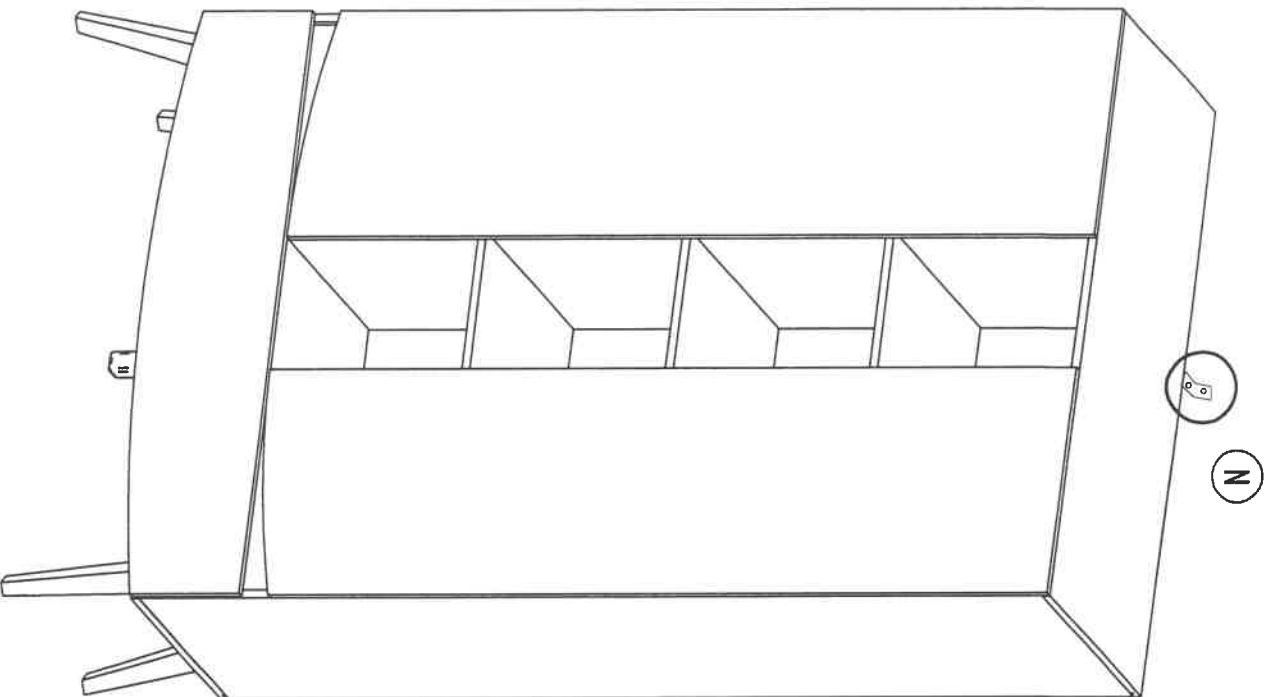

Wandbefestigung:

Den Schrank an der Wand befestigen.

Dazu Kipschutz **(N)** entsprechend  
beiliegender Anleitung anschrauben.  
Anschließend Kipschutz an der Wand  
befestigen. Für die Wand geeignete Dübel  
verwenden. Vor dem Bohren den Verlauf von  
Strom- und Wasserleitungen unbedingt  
überprüfen und berücksichtigen !

### **Achtung !**

Beim Befestigen des Schrankes an der Wand , muss das Montagematerial  
der Beschaffenheit der Wand entsprechen !

Kipschutz mit Anleitung ist im Beschlagbeutel

### **Attention !**

If the cupboard is attached to the wall the assembly material has to be  
appropriate for the composition of the wall !

Anti-tip device with instructions is in the fitting bag

### **Attentie !**

Als de kast aan de muur wordt bevestigd, moet het bevestigingsmateriaal  
overeenkomen met de aard van de muur.

De anti-tipper met instructies zit in de montagezak !

Montagehilfe für die Füße

Unterboden mit Nut hinten

Bitte die Füße entsprechend  
der Schablone ausrichten und mit den  
Schrauben **E** verschrauben

Unterboden vorn

